



Norme ISO applicabili per la certificazione di prodotto e il LCA

Dr. Giorgio Merlante – IDEA.NET

I Criteri Ambientali Minimi CAM e il programma EPD Italy Economia Circolare e Edilizia Sostenibile

4 Aprile 2017, Regione Emilia-Romagna, Via della fiera n. 8 Bologna, Sala Poggioli
(mattino) 09:00-13.30 e (pomeriggio) 14.30-16:00

IDEA.NET
è una rete con soggettività giuridica
e unisce le società:

Delta Engineering Services srl
Istituto Delta srl
Enecor srl



La rete riunisce più di 20 specialisti nei settori
Ambiente ed Ecologia



Via B. Bartok 29/B -44124 Ferrara (FE) , P.I. 01976240380
Tel. + 39 0532 977085 - Fax: +39 0532 977801 - E-mail:
info@ideapuntonet.it

seguici su

www.ideapuntonet.it



Servizi integrati Ambiente - Territorio

IDEA.NET è un contratto di rete nato dalla volontà e dall'impegno di tre aziende di Ferrara di riunire funzioni e competenze per lo sviluppo di un portafoglio di servizi integrati nei settori Ambiente e Territorio.

La rete offre agli operatori del settore pubblico e privato un pacchetto strutturato di servizi che spaziano dall'assunzione della delega per la gestione completa del tema Ambiente, al supporto di consulenza per specifici argomenti tecnici.

*Imprese in rete
per un'offerta di servizi
integrata*

Indagini e progettazione
ambientale

Ecologia applicata

Geologia territoriale

Bonifica dei siti contaminati

Check-up ambientali

IDEA.NET
è una rete con soggettività giuridica
e unisce le società:

Delta Engineering Services srl
Istituto Delta srl
Enecor srl



Offerta Integrata di competenze:

- **Edilizia Sostenibile**
- **Trasferimento Tecnologico nel settore Green**
- **Sviluppo Rurale**

Sostenibilità dei prodotti per edilizia - LCA

- Sviluppo della normativa e concetto di Sostenibilità
- Normativa inerente il Life Cycle Assessment (LCA)
- Metodologia per l'LCA
- Tools e Software disponibili

Sostenibilità dei prodotti per edilizia

Definizioni e normativa di riferimento

- ISO 14001 – Environmental management systems
- ISO 14020 – Environmental Labels and declarations – General principles
- ISO 14025 – Environmental Labels and declarations – Type III Declarations
- ISO 14040 – Environmental Management – Life Cycle assessment – Principles and farmework
- ISO 14044 – Environmental Management – Life Cycle assessment – Requirements
- ISO 14020 – Etichette e dichiarazioni ambientali
- ISO 14067 – Carbon Footprint
- ISO 15392 – Sustainability in building construction
- ISO 15686 – Building and constructed assets
-

SOSTENIBILITA'

NORME DI SISTEMA



NORME DI PRODOTTO

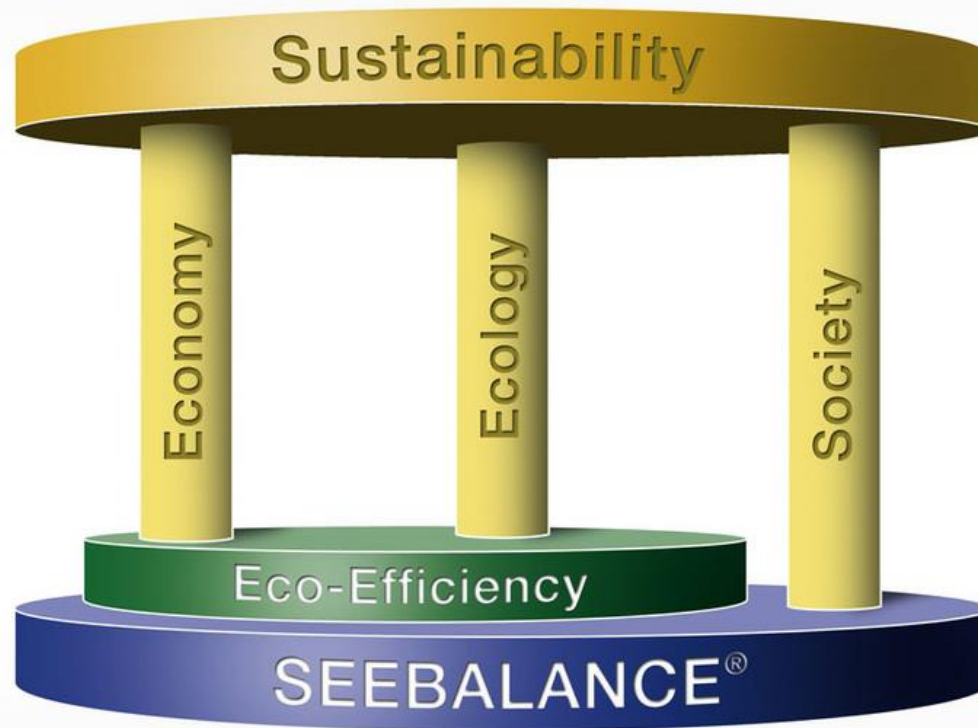

 **BASF**
We create chemistry

Opportunità per i produttori

Sustainability areas of action



Contribution to a company's success

**Generating
business –
Differentiating**

- Access new target groups and markets
- Increase market-differentiation
- Increase customer retention

**Enhancing
business -
Essential**

- Strengthen brand image
- Optimally leverage resources (incl. staff)
- Generate beneficial business environment

**Managing Risk -
Mandatory**

- Ensure that laws are respected
- Minimize material risk
- Reduce reputational risk



 **BASF**
We create chemistry

SEECube

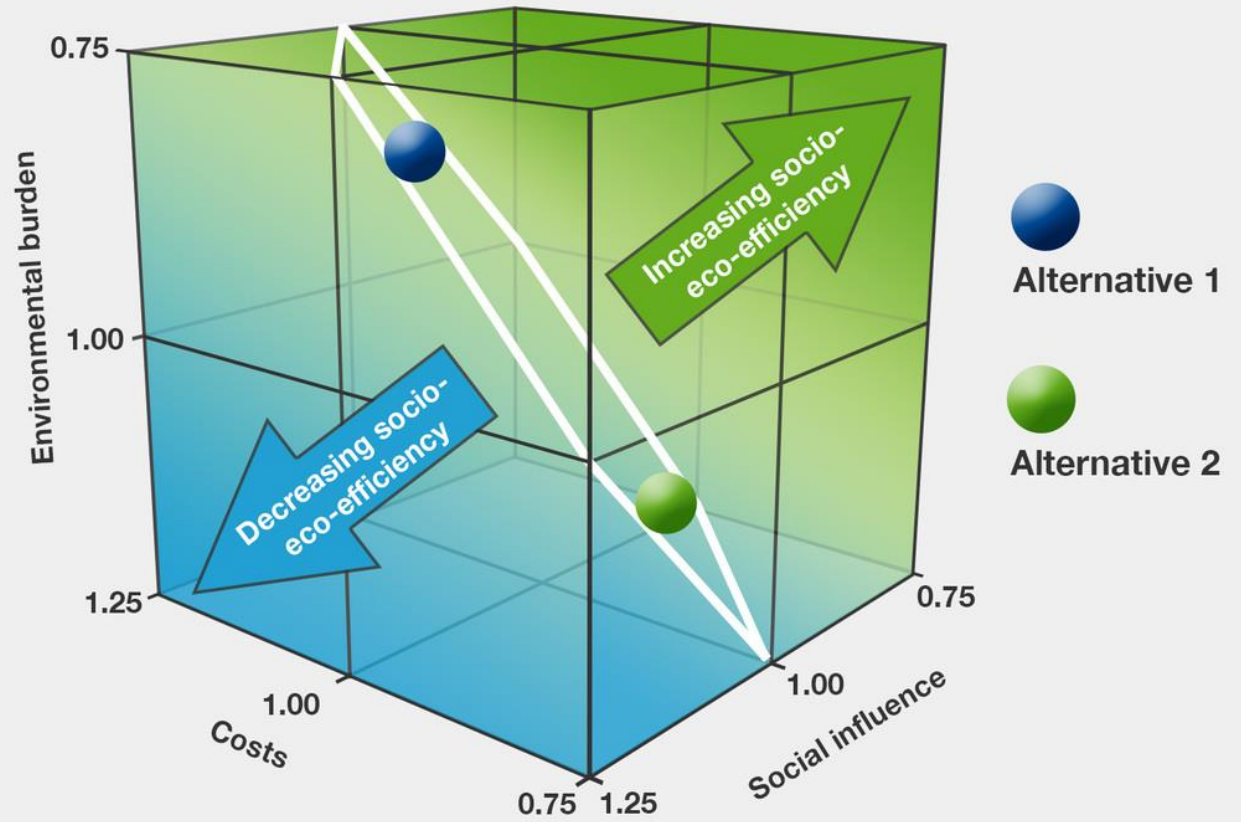

Certificazione Ambientale di Prodotto

Life Cycle Assessment (LCA) – Strumento metodologico per valutare l’impatto ambientale

- **ISO 14040 – Environmental Management – Life Cycle assessment – Principles and farmework**
 - ISO 14041 – Obiettivi e scopo
 - ISO 14042 – Valutazione impatto
 - ISO 14043 - Interpretazione

- **ISO 14044 – Environmental Management – Life Cycle assessment – Requirements**

- **ISO 14067 – Carbon Footprint**

Certificazione Ambientale di Prodotto

La norma ISO 14040 – Environmental Management – Life Cycle assessment – descrive i principi ed il quadro di riferimento per la valutazione del ciclo di vita:

- a) Definizione dell'obiettivo e del campo di applicazione
- b) Fase di Inventario del ciclo di vita LCI
- c) Fase di valutazione dell'impatto del ciclo di vita
- d) Fase di interpretazione del ciclo di vita
- e) Rendicontazione e revisione critica

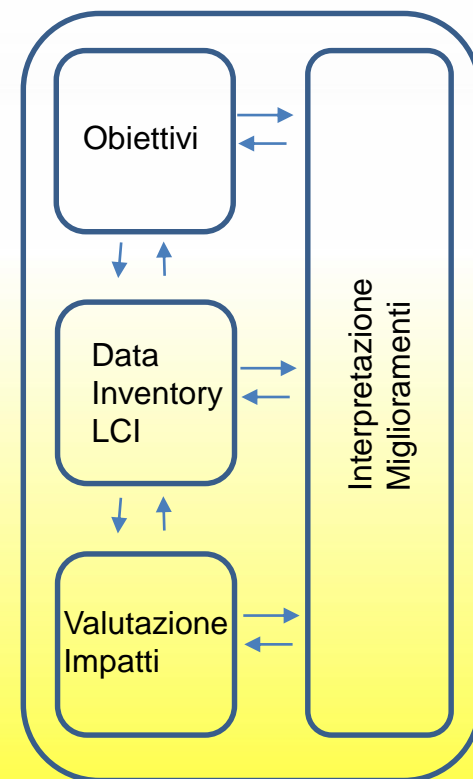

Certificazione Ambientale di Prodotto LCA

Definizione delle categorie di impatto LCIA:

- a) Effetto serra (GWP100)
- b) Assottigliamento della fascia di ozono
- c) Acidificazione
- d) Eutrofizzazione
- e) Formazione di smog fotochimico

kg CO₂ eq
kg CFC-11 eq
kg SO₂ eq
kg PO₄ --- eq
kg C₂H₄ eq

Informazioni ambientali aggiuntive:

- f) Tossicità per l'uomo e per l'ambiente
- g) Impatti e potenziali impatti sulla biodiversità
- h) Aspetti geografici sulla localizzazione del sistema di produzione
- f) Rifiuti
- g) Acqua, terreno e aria

Impact category	Unit
Abiotic depletion	kg Sb eq
Acidification	kg SO ₂ eq
Eutrophication	kg PO ₄ --- eq
Global warming (GWP100)	kg CO ₂ eq
Ozone layer depletion (ODP)	kg CFC-11 eq
Human toxicity	kg 1,4-DB eq
Fresh water aquatic ecotox.	kg 1,4-DB eq
Marine aquatic ecotoxicity	kg 1,4-DB eq
Terrestrial ecotoxicity	kg 1,4-DB eq
Photochemical oxidation	kg C ₂ H ₄

Certificazione Ambientale di Prodotto LCA

Metodi di calcolo degli indicatori ambientali

- CML 2001
- EDIP 1997 & EDIP 2003
- Eco-Indicator 99 (all three perspectives)**
- Carbon Footprint)
- Ecological Scarcity 1997 & 2006 & 2013
- Ecosystem Damage Potential (EDP)
- Environmental Priority Strategy (EPS 2000)
- Cumulative Energy Demand (CED)
- Cumulative Exergy Demand (CExD)
- IPCC 2001, IPCC 2007, IPCC 2013
- IMPACT 2002+
- TRACI
- USEtox
- ReCiPe (Midpoint and Endpoint)

Certificazione Ambientale di Prodotto LCA

Definizione di prodotto per il calcolo dell'LCA:

- a) Unità funzionale e dichiarata
- b) Confini di sistema
- c) Inventory dei dati
- d) Allocazione dei flussi energetici e dei materiali

Certificazione Ambientale di Prodotto LCA

Confini di sistema

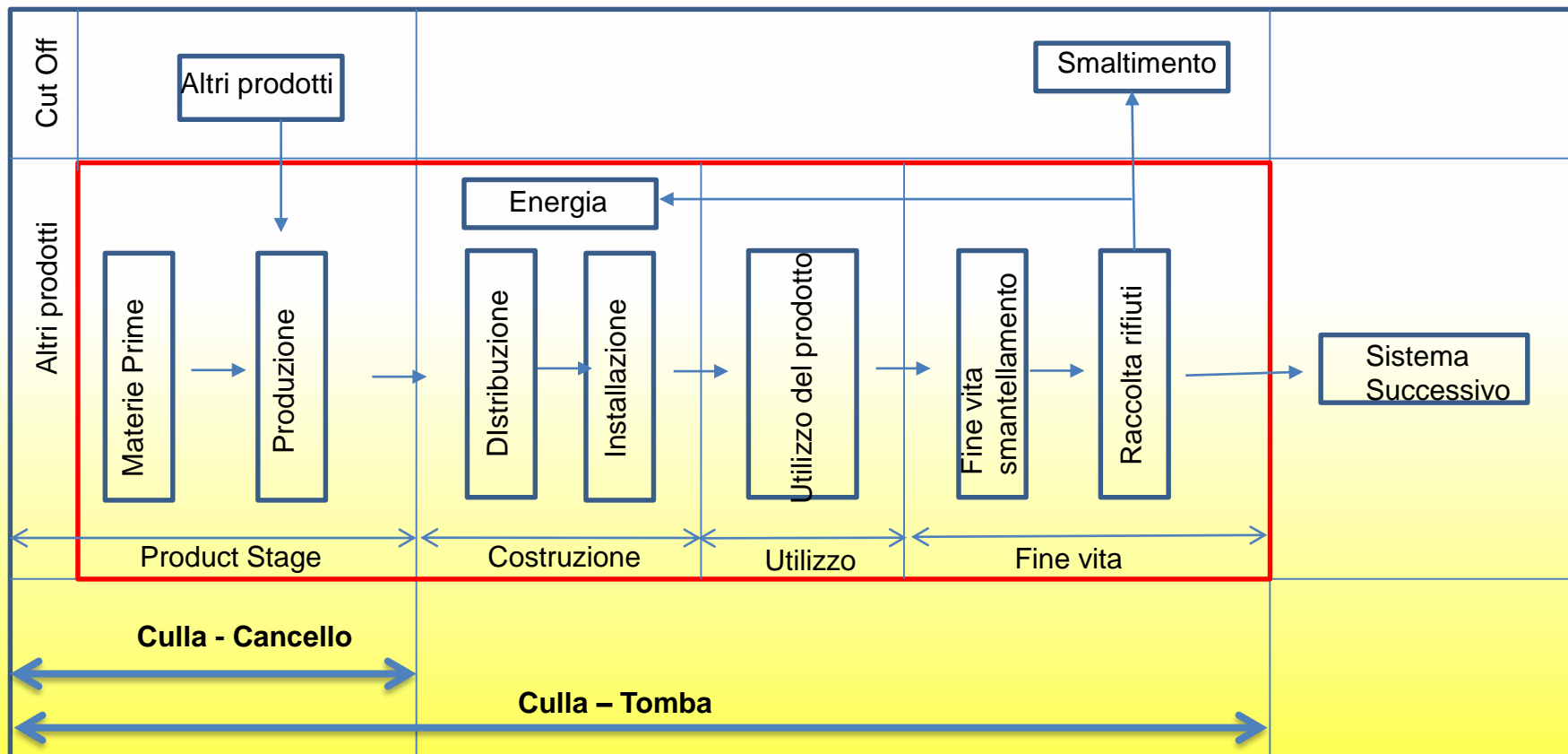

Certificazione Ambientale di Prodotto LCA

Inventory dei dati – Coinvolgimento della filiera – Qualità dei dati

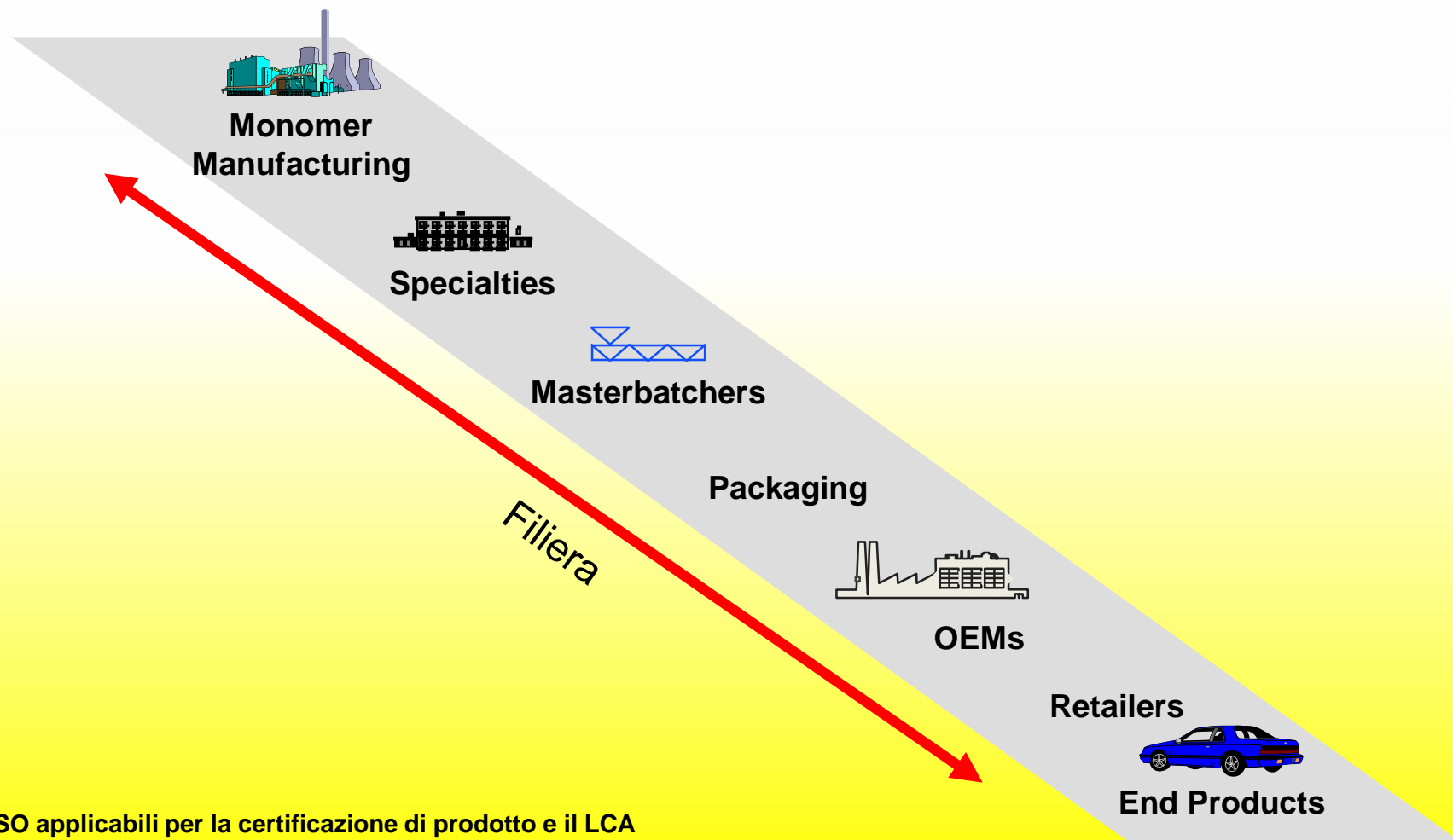

Certificazione Ambientale di Prodotto LCA

Inventory dei dati – Banche dati

- Energy supply
- Chemicals
- Plastics and Plastics Production
- Production and processing of metals
- Transport & Mobility
- Disposal
- Construction
- Agriculture (including pesticides)
- Information and Communication Technology
- Electronics
- Bio-fuels and materials
- Engineering
- Paper Industry
- Recycling Processes
- Water Data



Ecoinvent V.3 e GaBi Database contengono più di 11500 data sets per Settori diversi. I data base sono aggiornati periodicamente.

Tools e software per LCA

Esistono numerosi software che aiutano l'effettuazione del ciclo di vita, i Requisiti richiesti sono:

-) **Corrispondenza con le norme ISO 14040**
-) **Integrazione con banche dati di prodotti e di processi riconosciute ed accettate**
-) **Utilizzo di metodologie di valutazione dell'impatto riconosciute**
-) **Disponibilità dell'analisi di sensitività per dimostrare l'incertezza di misura (come richiesto dalla ISO14044:2006)**

Tools e software per LCA

  	  	 
---	---	---

Tools e software per LCA

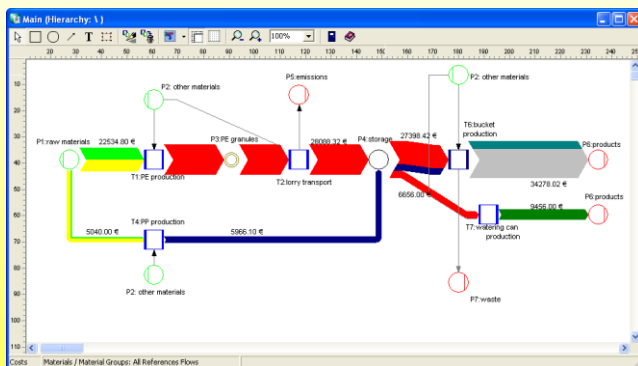
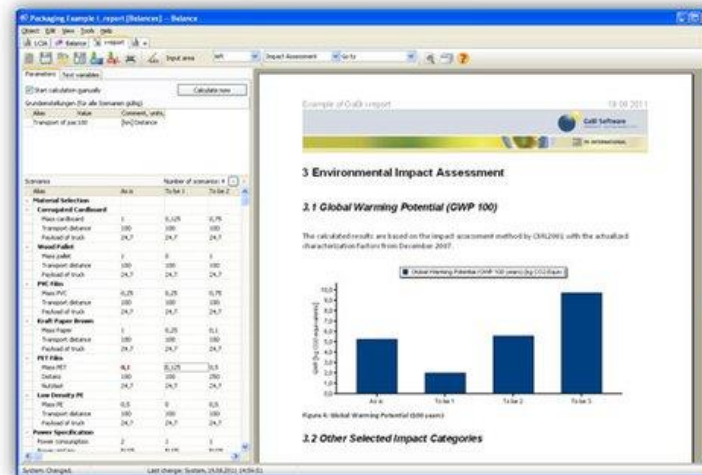
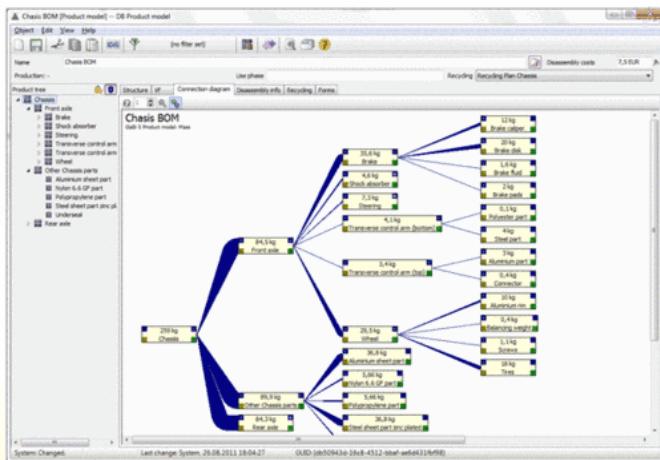

Tools e software per LCA – esempio di output

Impact category	Unit	2008 production		
		Produzione 0.8	Produzione FR	Produzione Accoppiato
Abiotic depletion	kg Sb eq	0.150	0.157	0.175
Acidification	kg SO2 eq	0.183	0.193	0.223
Eutrophication	kg PO4 ⁻⁻⁻ eq	0.347	0.346	0.351
Global warming (GWP100)	kg CO2 eq	19.2	20.6	23.6
Ozone layer depletion (ODP)	kg CFC-11 eq	0.000	0.000	0.000
Human toxicity	kg 1,4-DB eq	0.933	0.978	1.072
Fresh water aquatic ecotox.	kg 1,4-DB eq	0.547	0.630	1.096
Marine aquatic ecotoxicity	kg 1,4-DB eq	27.3	28.7	30.7
Terrestrial ecotoxicity	kg 1,4-DB eq	0.088	0.092	0.140
Photochemical oxidation	kg C2H4	0.007	0.008	0.009

Tabella n°2 – Risultati per categorie di impatto



Figura n°5 – Impatto Global Warming GWP100

Tools per effettuare un LCA

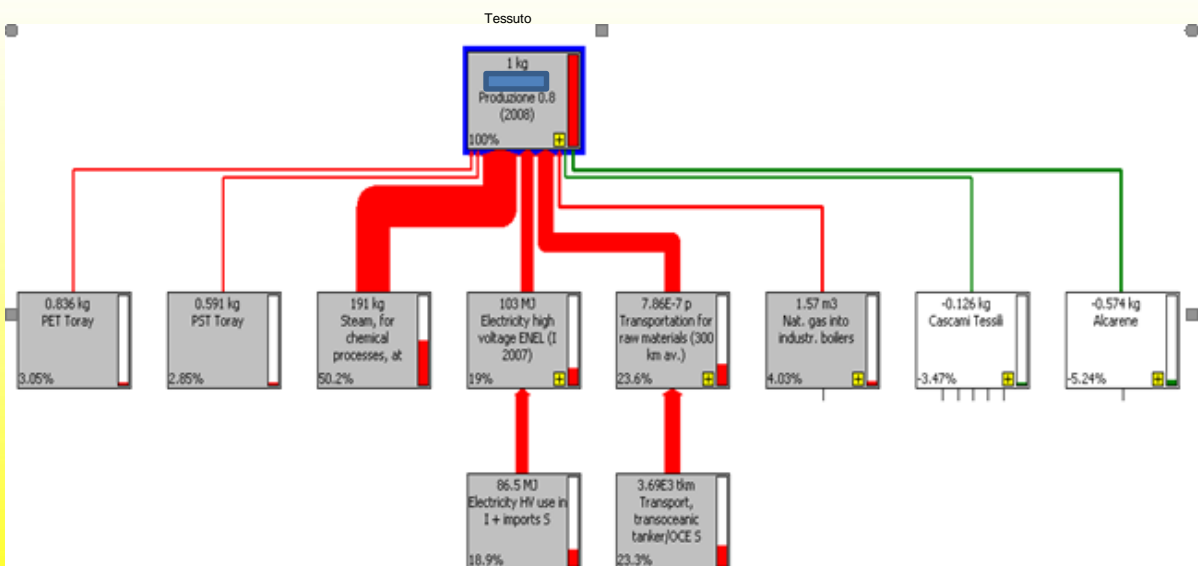

SIGN IN or REGISTER 

HOME

PRODUCTS

PROJECTS

GREEN PEOPLE

RESOURCES

NEWS

Follow us



NEW PRODUCTS



“ WE ASSESSED THOUSANDS OF PRODUCTS COMPLIANT WITH GREEN BUILDING STANDARDS. ”

Tools per effettuare un LCA



Recently Added Products

See All

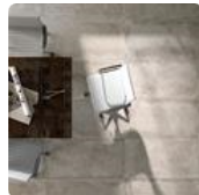

WALKING EXTRA
NOVABELL
Ceramic tiles for interiors

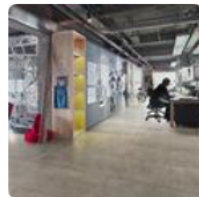

TRIBECA
NOVABELL
Ceramic tiles for interiors



PF 10
EDILCOL ITALIA
Mineral-based paint

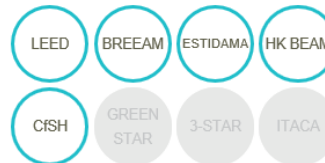

LIFESTYLE
ABITA CERAMICHE ITALIANE
Ceramic tiles for interiors



“ WE ASSESSED THOUSANDS OF PRODUCTS COMPLIANT WITH GREEN BUILDING STANDARDS. ”

FIND GREEN PRODUCTS
in just 2 clicks!

enter keyword

► Or Browse products by category

SEARCH

FILTER BY

► GREEN RATING SYSTEM

► GEOGRAPHIC AREA

► MANUFACTURERS/BRANDS

PUBLISH YOUR PROJECT



GRAZIE PER L'ATTENZIONE,

Dott. Giorgio Merlante

Società IDEA.NET



Telefono +39 335 6324775

E-mail giorgio.merlante@ideapuntonet.it